

Air Conditioning

Product Information

PLFY-P50VFM-E
600 x 600 4-Way Blow
Ceiling Cassette

Making a
World of
Difference

CITY MULTI



The PLFY cassette unit provides the smart solution to comfortable and efficient air conditioning. It combines a stylish square design slimline grille with the latest energy-saving technologies and is designed to fit snugly to ceilings making it ideal in both offices and retail.

Key Features

- New Design - Fits into narrow ceiling spaces with height of only 245mm
- Low Noise Levels - Reduced noise value with 3D turbo fan
- Horizontal Airflow - Eliminating uncomfortable drafts and improved airflow control
- Easy Installation - Temporary hanging hook on grille and no screw removal for corner panel / control box



Air Conditioning | Heating
Ventilation | Controls

Air Conditioning

Product Information

PLFY-P50VFM-E 600 x 600 4-Way Blow Ceiling Cassette

Making a
World of
Difference

PLFY-P - INDOOR UNITS		PLFY-P50VFM-E
CAPACITY (kW)	Heating (nominal)	6.3
	Cooling (nominal)	5.6
	Heating (UK)	6.3
	UK Total Cooling - Hi (Sensible)	5.00 (3.60)
	UK Total Cooling - Mi1	4.78
	UK Total Cooling - Lo	4.41
	UK Total Cooling - Hi (Sensible) (Raised Evaporation Temperature*)	- (-)
POWER INPUT (kW)	Heating (nominal)	0.03
	Cooling (nominal)	0.03
AIRFLOW (l/s)	Lo-Mi1-Hi	150-183-217
SOUND PRESSURE LEVEL (dBA)	Lo-Mi1-Hi	33-39-43
WEIGHT (kg)	(Grille)	15 (3)
DIMENSIONS (mm)	Width	570 (625)
	Depth	570 (625)
	Height	208 (10)
ELECTRICAL SUPPLY		220-240v, 50Hz
PHASE		Single
RUNNING CURRENT (A)	Heating	0.35
	Cooling	0.4
FUSE RATING (BS88) - HRC (A)		6
MAINS CABLE No. Cores		3
GRILLE MODEL REFERENCE		SLP-2FA

DIMENSIONS

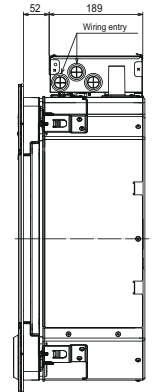
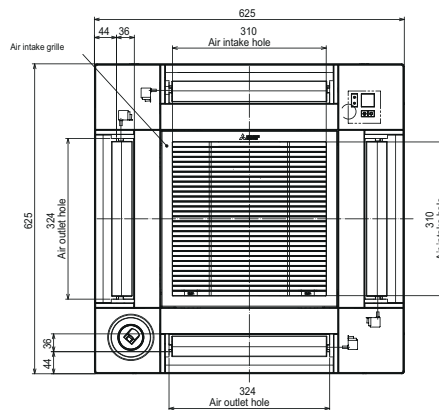
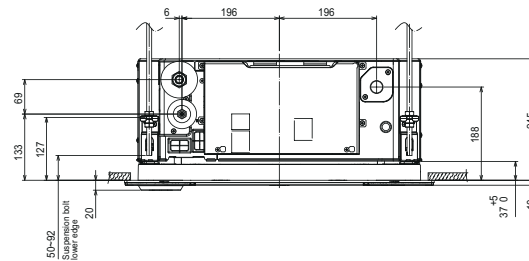
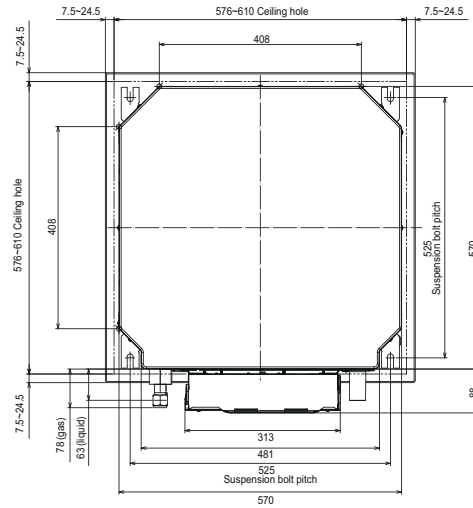

Notes:
* Figures available separately. Please consult with your sales office for application of this feature.



Telephone: 01707 282880

email: air.conditioning@meuk.mee.com web: www.airconditioning.mitsubishielectric.co.uk

UNITED KINGDOM Mitsubishi Electric Europe Living Environmental Systems Division
Travellers Lane, Hatfield, Hertfordshire, AL10 8XB, England General Enquiries Telephone: 01707 282880 Fax: 01707 278881

IRELAND Mitsubishi Electric Europe Westgate Business Park, Ballymount, Dublin 24, Ireland
Telephone: Dublin (01) 419 8800 Fax: Dublin (01) 419 8890 International code: (00353)1

Country of origin: United Kingdom - Japan - Thailand - Malaysia. ©Mitsubishi Electric Europe 2016. Mitsubishi and Mitsubishi Electric are trademarks of Mitsubishi Electric Europe B.V. The company reserves the right to make any variation in technical specification to the equipment described, or to withdraw or replace products without prior notification or public announcement. Mitsubishi Electric is constantly developing and improving its products. All descriptions, illustrations, drawings and specifications in this publication present only general particulars and shall not form part of any contract. All goods are supplied subject to the Company's General Conditions of Sale, a copy of which is available on request. Third-party product and brand names may be trademarks or registered trademarks of their respective owners.



Note: The fuse rating is for guidance only. Please refer to the relevant databook for detailed specification. It is the responsibility of a qualified electrician/electrical engineer to select the correct cable size and fuse rating based on current regulation and site specific conditions. Mitsubishi Electric's air conditioning and heat pump systems contain fluorinated greenhouse gases R410A, R407C and R134a.



www.greengateway.mitsubishielectric.co.uk

Mitsubishi Electric UK's commitment
to the environment

Follow us @meuk_Jes
Follow us @green_gateway

Mitsubishi Electric
Living Environmental Systems UK

YouTube
mitsubishielectric2

Effective as of May 2016